

# Anschlussköpfe optional Connection heads options Têtes de branchement options

Anschlussköpfe mit Schraubverschluss Connection heads with screwed plug Têtes de branchement avec fermeture à vis		Anschlussköpfe mit Schraubdeckel Connection heads with screwed cap Têtes de branchement avec couvercle vissé	
Form Form Forme	DIN 43729 / Form A	Feldgehäuse field case boîtier pour montage sur site	Feldgehäuse field case boîtier pour montage sur site
Material Material Matière	Aluminium aluminium duralumin	Aluminium aluminium duralumin	1.4301 304 Z6 CN 18-09
Schutzart Protection Degré de protection	IP 65	IP 65	IP 65
Bestell-Nr. Order-N°. N° de commande	395681	396122	396123
Anschlussköpfe mit Schraubdeckel Connection heads with screwed cap Têtes de branchement avec couvercle vissé			
Form Form Forme	Form GT	Form NS	Form D
Material Material Matière	Grauguss Grey cast Fonte grise	ITAMID / NORYL	Aluminium aluminium duralumin
Schutzart Protection Degré de protection	IP 65	IP 65	IP 65
Bestell-Nr. Order-N°. N° de commande	395684	395686	395689
Anschlussköpfe mit Schnellverschluss Connection heads with quick closure Têtes de branchement avec fermeture rapide			
Form Form Forme	Form DANW	Form DAN	Form C
Material Material Matière	Aluminium aluminium duralumin	Aluminium aluminium duralumin	1.4301 / 1.4571 304 / 316Ti Z6 CN 18-09 / Z6CNDT 17-12
Schutzart Protection Degré de protection	IP 65	IP 65	IP 65
Bestell-Nr. Order-N°. N° de commande	395685	395688	395683

Stand: 19. 04 2017

# Klemmringverschraubung und Kugel-Quetschdichtung Compression fitting and ball compression seal Raccord coulissant et joint sphérique à compression

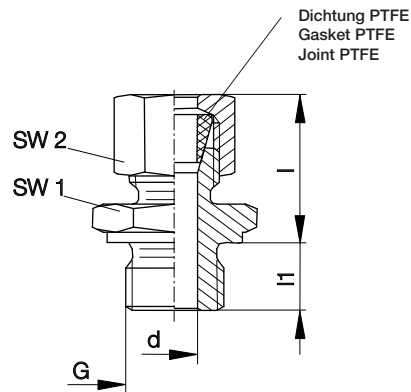

Klemmringverschraubung, PN25, max. 230 °C Compression fitting, PN25, max. 230 °C Raccord coulissant, PN25, max. 230 °C						
Bestell-Nr. Order-N° N° de commande	d	G	l	l1	SW1	SW2
mm						
411124	1	M8 x 1	20	8	10	10
411125	1,5	M8 x 1	20	8	10	10
411126	2	M8 x 1	20	8	10	10
411127	3	M8 x 1	20	8	10	10
411128	4	M8 x 1	20	8	10	10
395887	6,2	M10 x 1	23	8	14	14
396319	6,2	M12 x 1,5	25	8	17	17
395888	8,2	M12 x 1,5	25	12	17	17
396262	9,2	M14 x 1,5	26	12	19	19
395745	9,2	M16 x 1,5	26	12	22	19
396054	11,2	M16 x 1,5	27	12	22	22
396297	14,2	M18 x 1,5	27	12	24	27
396298	15,2	M18 x 1,5	29	12	24	27
396152	4,2	NPT 1/8"	22	10	11	10
396273	6,2	NPT 1/8"	22	10	12	14
396277	6,2	NPT 1/4"	23,5	14,5	17	14
396278	8,2	NPT 1/4"	23,5	14,5	17	17
396279	9,2	NPT 1/4"	23,5	14,5	17	19
396281	6,2	NPT 3/8"	23,5	14,5	19	14
396282	8,2	NPT 3/8"	23,5	14,5	19	17
396283	9,2	NPT 3/8"	23,5	14,5	19	19
396284	11,2	NPT 3/8"	23,5	14,5	19	22
396287	6,2	NPT 1/2"	24,5	19,5	22	14
396288	8,2	NPT 1/2"	24,5	19,5	22	17
396289	9,2	NPT 1/2"	24,5	19,5	22	19
396290	11,2	NPT 1/2"	24,5	19,5	22	22

Klemmringverschraubung, PN25, max. 230 °C Compression fitting, PN25, max. 230 °C Raccord coulissant, PN25, max. 230 °C						
Bestell-Nr. Order-N° N° de commande	d	G	l	l1	SW1	SW2
mm						
396291	14,2	NPT 1/2"	24,5	19,5	24	27
396292	15,2	NPT 1/2"	24,5	19,5	24	27
396263	6,2	G 1/8 B	23	8	14	14
396264	8,2	G 1/8 B	23,5	8	17	17
396265	9,2	G 1/8 B	25,5	8	17	19
396266	11,2	G 1/8 B	25,5	8	19	22
396150	6,2	G 1/4 B	24,5	12	19	14
396151	8,2	G 1/4 B	25	12	19	17
396267	9,2	G 1/4 B	26	12	19	19
396268	11,2	G 1/4 B	26	12	19	22
396269	6,2	G 3/8 B	26	12	22	14
396270	8,2	G 3/8 B	26	12	22	17
396271	9,2	G 3/8 B	27,5	12	22	19
396272	11,2	G 3/8 B	27,5	12	22	22
396293	14,2	G 3/8 B	27,5	12	22	27
396294	15,2	G 3/8 B	27,5	12	22	27
395738	6,2	G 1/2 B	26,5	14	27	14
395739	8,2	G 1/2 B	26,5	14	27	17
395886	9,2	G 1/2 B	29	14	27	19
396055	11,2	G 1/2 B	28	14	27	22
396295	14,2	G 1/2 B	29	14	27	27
396296	15,2	G 1/2 B	28	14	27	27
396530	12,5	G3/4B	-	-	-	-
396606	15,2	G3/4B	30	14	27	32
415870	6,0 - 20,0	G1B	-	-	-	-

Kugel-Quetschdichtung, PN25, max. 230 °C Ball compression seal, PN25, max. 230 °C Joint sphérique à compression, PN25, max. 230 °C					
Bestell-Nr. Order-N° N° de commande	d	Kugel Ball Balle	l	l1	SW
mm					
395975	6,2	25	7	18	22
395976	8,2				

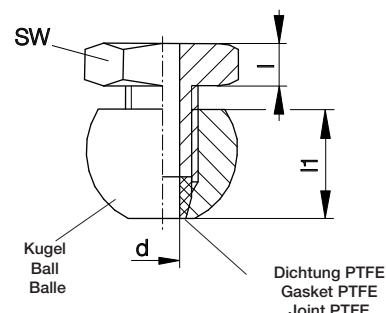

# Ergänzungen: Anschlussvarianten Optional extras: connection versions Options: variantes de raccordement

Anschlussvarianten Connection versions Variantes de raccordement				
Fabrikat Make Produit	Bestell-Nr. Order-N° N° de commande			
	Buchse Coupling Connecteur femelle		Stecker Plug Connecteur mâle	
	2-polig two-pole bipolaire	4-polig four-pole quadripolaire	2-polig two-pole bipolaire	4-polig four-pole quadripolaire
Lemosa 1 S    D =12mm	411316	413975	413953	413976
Lemosa 2 S    D =15mm	413954	413977	413955	413978
Binder	413956	413979	413957	413980

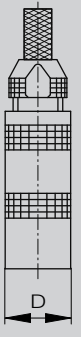
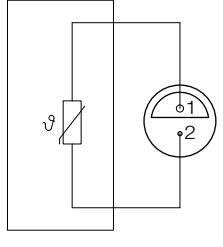
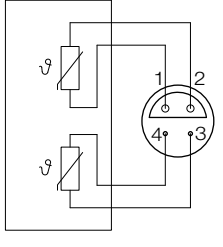
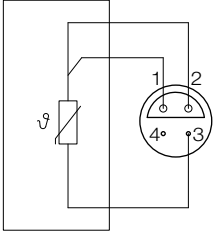
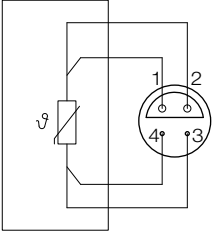
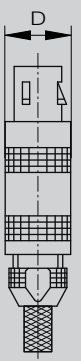
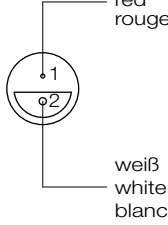
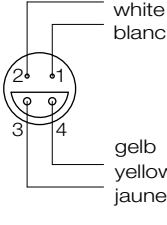
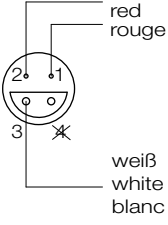
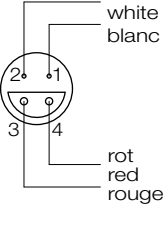
Lemosa-Buchse Lemosa-female connector Lemosa-connecteur femelle 	302 	304 	304 	304 
Lemosa-Stecker Lemosa-male connector Lemosa-connecteur mâle 	302  rot red rouge  weiß white blanc	304  weiß white blanc  gelb yellow jaune	304  rot red rouge  weiß white blanc	304  weiß white blanc  rot red rouge
	1 x Pt100 2-Leiter 1 x Pt100 2-wire 1 x Pt100 2-fils	2 x Pt100 2-Leiter 2 x Pt100 2-wire 2 x Pt100 2-fils	1 x Pt100 3-Leiter 1 x Pt100 3-wire 1 x Pt100 3-fils	1 x Pt100 4-Leiter 1 x Pt100 4-wire 1 x Pt100 4-fils

Stand: 19. 04 2017

Ergänzungsartikel Optional extras Options	T20	T30.5/6/8/9	T40/T45
	Bestell-Nr. Order-N°. N° de commande		
Halsrohr 30 mm lang Neck extension, length 30 mm Tube extension, longueur 30 mm	395731	-	-
Halsrohr 60 mm lang Neck extension, length 60 mm Tube extension, longueur 60 mm	395732	-	-
Halsrohr 90 mm lang Neck extension, length 90 mm Tube extension, longueur 90 mm	395733	-	-
Halsrohr 250 mm lang Neck extension, length 250 mm Tube extension, longueur 250 mm	395873	-	-
Halsrohrlänge vom Standard abweichend Neck extension length divergent to standard Longueur du tube extension divergent de le standard	396010	-	-
Schutzrohr auf 6mm abgesetzt, 60mm lang Thermowell at 6mm set down, length 60mm Doigt de grant déposer 6mm, longueur 60mm	396115	-	-
Schutzrohr perforiert für flüssige Medien Thermowell perforate for liquid media Doigt de grant perforer pour média liquid	396136	-	-
Schutzrohr perforiert für gasförmige Medien Thermowell perforate for gaseous media Doigt de grant perforer pour média gazeux	396084	-	-
Einbaulänge vom Standard abweichend Useful length divergent to standard Longueur utile divergent de le standard	396011	396011	396011
Messwiderstand nach DIN EN 60751, Pt500 mit 3-Leiteranschluss Measurement resistance per DIN EN 60751, Pt500 with 3 wire circuit Résistance thermométrique selon DIN EN 60751, Pt500, 3 fils	395877	395877	395877
Messwiderstand nach DIN EN 60751, Pt1000 mit 3-Leiteranschluss Measurement resistance per DIN EN 60751, Pt1000 with 3 wire circuit Résistance thermométrique selon DIN EN 60751, Pt1000, 3 fils	395878	395878	395878
Messwiderstand nach DIN 43760, Ni100 mit 3-Leiteranschluss Measurement resistance per DIN 43760, Ni100 with 3 wire circuit Résistance thermométrique selon DIN 43760, Ni100, 3 fils	395879	395879	395879
Messwiderstand mit 2-Leiteranschluss Measurement resistance with 2 wire circuit Résistance thermométrique avec 2 fils	395709	395709	395709
Messwiderstand mit 4-Leiteranschluss Measurement resistance with 4 wire circuit Résistance thermométrique avec 4 fils	395710	-	395710
Doppel-Messwiderstand mit 3-Leiteranschluss Dual measurement resistance with 3 wire circuit Résistance thermométrique double avec 3 fils	395711	-	395711
Anschlusskopf mit HAN-7-D Stecker Connection head with HAN-7-D connector Tête de raccordement avec HAN-7-D connecter	390876	-	-
Zündschutzart : Intrinsic safety : Sécurité intrinsèque :	396418	-	-

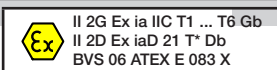

Ergänzungsartikel Optional extras Options	Bestell-Nr. Order-N°. N° de commande	
	T21/T22	T41/T46
	Einbaulänge vom Standard abweichend Useful length divergent to standard Longueur utile divergent de le standard	396011
Halsrohr 30 mm lang Neck extension, length 30 mm Tube extension, longueur 30 mm	395731	-
Halsrohr 60 mm lang Neck extension, length 60 mm Tube extension, longueur 60 mm	395732	-
Halsrohr 90 mm lang Neck extension, length 90 mm Tube extension, longueur 90 mm	395733	-
Halsrohr 250 mm lang Neck extension, length 250 mm Tube extension, longueur 250 mm	395873	-
Halsrohrlänge vom Standard abweichend Neck extension length divergent to standard Longuer du tube extension divergent de le standard	396010	-
Schutzrohr auf 6mm abgesetzt, 60mm lang Thermowell at 6mm set down, length 60mm Doigt de grant déposer 6mm, longueur 60mm	396115	-
Thermopaar nach DIN EN 60584 2x Fe-CuNi Typ (J) Thermocouple per DIN EN 60584 2x Fe-CuNi type (J) Thermocouple selon DIN EN 60584 2x Fe-CuNi type (J)	395880	-
Doppel-Thermopaar nach DIN EN 60584 2x Fe-CuNi Typ (J) Dual thermocouple per DIN EN 60584 2x Fe-CuNi type (J) Thermocouple double selon DIN EN 60584 2x Fe-CuNi type (J)	396021	396021
Doppel-Thermopaar nach DIN EN 60584 2x NiCr-Ni Typ (K) Dual thermocouple per DIN EN 60584 2x NiCr-Ni type (K) Thermocouple double selon DIN EN 60584 2x NiCr-Ni type (K)	395889	395889
Thermopaar nach DIN EN 60584 Pt13Rh-Pt Typ (R) Thermocouple per DIN EN 60584 Pt13Rh-Pt type (R) Thermocouple selon DIN EN 60584 Pt13Rh-Pt type (R)	395881	395881
Doppel-Thermopaar nach DIN EN 60584 2x Pt13Rh-Pt Typ (R) Dual thermocouple per DIN EN 60584 2x Pt13Rh-Pt type (R) Thermocouple double selon DIN EN 60584 2x Pt13Rh-Pt type (R)	396022	396022
Thermopaar nach DIN EN 60584 Pt10Rh-Pt Typ (S) Thermocouple per DIN EN 60584 Pt10Rh-Pt type (S) Thermocouple selon DIN EN 60584 Pt10Rh-Pt type (S)	396520	-
Doppel-Thermopaar nach DIN EN 60584 2x Pt10Rh-Pt Typ (S) Dual thermocouple per DIN EN 60584 2x Pt10Rh-Pt type (S) Thermocouple double selon DIN EN 60584 2x Pt10Rh-Pt type (S)	396521	-
Thermopaar nach DIN EN 60584 Pt30Rh-Pt6Rh Typ (B) Thermocouple per DIN EN 60584 Pt30Rh-Pt6Rh type (B) Thermocouple selon DIN EN 60584 Pt30Rh-Pt6Rh type (B)	396522	-
Doppel-Thermopaar nach DIN EN 60584 2x Pt30Rh-Pt6Rh Typ (B) Dual thermocouple per DIN EN 60584 2x Pt30Rh-Pt6Rh type (B) Thermocouple double selon DIN EN 60584 2x Pt30Rh-Pt6Rh type (B)	396523	-
Thermopaar nach DIN 43710 Fe-CuNi Typ (L) Thermocouple per DIN 43710 Fe-CuNi type (L) Thermocouple selon DIN 43710 Fe-CuNi type (L)	396524	-
Doppel-Thermopaar nach DIN 43710 2x Fe-CuNi Typ (L) Dual thermocouple per DIN 43710 2x Fe-CuNi type (L) Thermocouple double selon DIN 43710 2x Fe-CuNi type (L)	396525	-

Ergänzungsartikel Optional extras Options	Bestell-Nr. Order-N°. N° de commande			
	T53	T61	T63.5/6	T81
	Nennlänge vom Standard abweichend Length divergent to standard Longueur divergent de le standard	396242	396242	-
Ausgleichsleitung Fe-CuNi (J), Silicon / Keramik / Glasseide / Edelstahl Compensating cable Fe-CuNi (J), silicon / ceramic / glas silk / stainless steel Câble de compensation Fe-CuNi (J), silicone / céramique / soie de verre / acier inox	396517	-	-	396517
Ausgleichsleitung Fe-CuNi (L), Silicon / Keramik / Glasseide / Edelstahl Compensating cable Fe-CuNi (L), silicon / ceramic / glas silk / stainless steel Câble de compensation Fe-CuNi (L), silicone / céramique / soie de verre / acier inox	396518	396518	-	396518
Ausgleichsleitung NiCr-Ni (K), Silicon / Keramik / Glasseide / Edelstahl Compensating cable NiCr-Ni (K), silicon / ceramic / glas silk / stainless steel Câble de compensation NiCr-Ni (K), silicone / céramique / soie de verre / acier inox	396519	396519	396519	396519

Stand: 19. 04 2017

**Ergänzungsartikel**  
**Optional extras**  
**Options**

Bestell-Nr.  
Order-N°.  
N° de commande

	T50/60	T51/62/62.04 63.1/.2/.3
Nennlänge vom Standard abweichend Length divergent to standard Longueur divergent de le standard	396242	396242
Silicon-Kabel, je weiterer Meter silicon-cable, each further meter silicone-câble, par mètre	396243	396243
Messwiderstand nach DIN EN 60751, Pt500 mit 3-Leiteranschluss Measurement resistance per DIN EN 60751, Pt500 with 3 wire circuit Résistance thermométrique selon DIN EN 60751, Pt500, 3 fils	395877	395877
Messwiderstand nach DIN EN 60751, Pt1000 mit 3-Leiteranschluss Measurement resistance per DIN EN 60751, Pt1000 with 3 wire circuit Résistance thermométrique selon DIN EN 60751, Pt1000, 3 fils	395878	395878
Messwiderstand nach DIN 43760, Ni100 mit 3-Leiteranschluss Measurement resistance per DIN 43760, Ni100 with 3 wire circuit Résistance thermométrique selon DIN 43760, Ni100, 3 fils	395879	395879
Kabel, Nickel / Teflon® / Glasseide / Edelstahl cable, nickel / Teflon® / glas silk / stainless steel câble, nikel / Téflon® / soie de verre / acier inox	2-adrig 2 wire 2 fils	396509 396509
Kabel, Nickel / Teflon® / Glasseide / Edelstahl cable, nickel / Teflon® / glas silk / stainless steel câble, nikel / Téflon® / soie de verre / acier inox	3-adrig 3 wire 3 fils	396510 396510
Kabel, Kupfer / Glasseide / Glasseide / Edelstahl cable, copper / glas silk / glas silk / stainless steel câble, cuivre / soie de verre / soie de verre / acier inox	2-adrig 2 wire 2 fils	396511 396511
Kabel, Kupfer / Glasseide / Glasseide / Edelstahl cable, copper / glas silk / glas silk / stainless steel câble, cuivre / soie de verre / soie de verre / acier inox	3-adrig 3 wire 3 fils	396512 396512
Kabel, Kupfer / Teflon® / Teflon® cable, copper / Teflon® / Teflon® câble, cuivre / Téflon® / Téflon®	2-adrig 2 wire 2 fils	396513 396513
Kabel, Kupfer / Teflon® / Teflon® cable, copper / Teflon® / Teflon® câble, cuivre / Téflon® / Téflon®	3-adrig 3 wire 3 fils	396514 396514
Kabel, Nickel / Teflon® / Edelstahl / Teflon® cable, nickel / Teflon® / stainless steel / Teflon® câble, nikel / Téflon® / acier inox / Téflon®	4-adrig 4 wire 4 fils	396515 396515
Zündschutzart : Intrinsic safty : Sécurité intrinsèque :	 II 2G Ex ia IIC T1 ... T6 Gb II 2D Ex iaD 21 T* Db BVS 06 ATEX E 083 X	396516 -

Stand: 19. 04 2017